



VORTEX

AUGER MULTIFUNCTION

Auger Highly versatile

The drill can be equipped with different types of tips and extension cords that allow to carry out various jobs, from the drilling of the ground, until the crushing of roots and tree stumps

VORTEX

 VIDEO



VORTEX 2

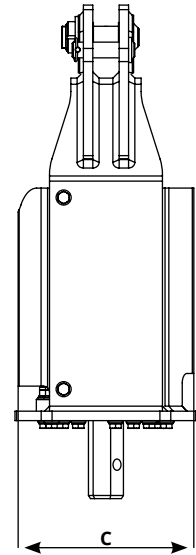
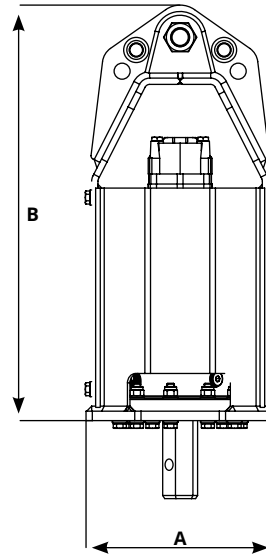

Tons	1.0 - 1.8	1.8 - 2.2	2.0 - 3.0	3.0 - 4.5	4.0 - 6.0	6.0 - 7.5	7.0 - 10.0	10.0 - 15.0	15.0 - 20.0
MODEL	V1	V2	V3	V4	V5	V6	V7	V8	V9
A (mm)	235	235	235	300	300	360	360	410	410
B (mm)	475	475	475	660	660	780	780	950	950
C (mm)	230	230	230	290	290	350	350	430	430
WRENCH	50	50	50	50	50	70	70	70	70
Without coupling weight Kg	59	62	62	100	105	180	180	260	283
Flow rate Min/Max (L/1')	20-30	25-40	30-50	40-60	50-70	60-80	80-90	90-120	110-150
Rev/min (RPM)	66	66	51	46	43	37	28	37	36
Pressure Bar	220	220	220	220	220	220	220	240	280
Torque Max. N/m	1.200	1.600	2.500	3.500	4.500	6.200	8.000	10.000	15.000
Drainage to tank	Suggested	Suggested	Suggested	Suggested	Suggested	Suggested	Suggested	Suggested	Mandatory



VORTEX 2F

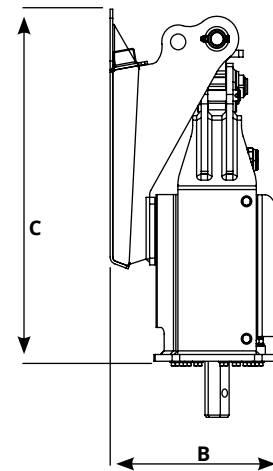
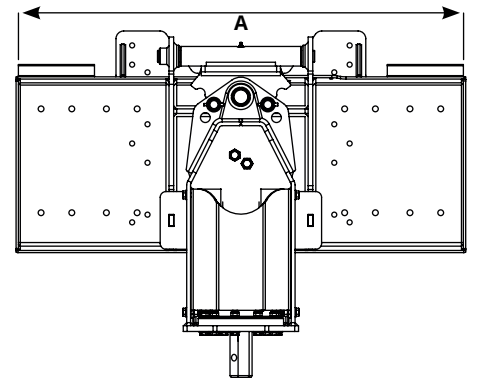





MODEL	V1	V2	V3	V4	V5
A (mm)	1170	1170	1170	1170	1170
B (mm)	356	356	356	384	384
C (mm)	593	593	593	780	780
WRENCH	50	50	50	50	50
Without coupling weight Kg	134	137	137	175	180
Flow rate Min/Max (L/1')	20-30	25-40	30-50	40-60	50-70
Rev/min (RPM)	66	66	51	46	43
Pressure Bar	220	220	220	220	220
Torque Max. N/m	1.200	1.600	2.500	3.500	4.500
Drainage to tank	Suggested	Suggested	Suggested	Suggested	Suggested

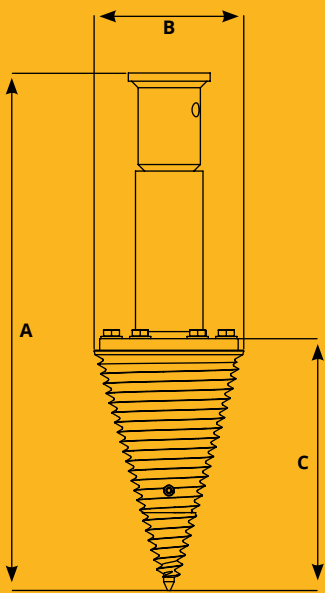

LOG SPLITTER CONICAL BIT

LOG SPLITTER CONICAL BIT





		
MODEL	V1 - V2 - V3 V4 - V5	V6 - V7 - V8 V9
A (mm)	550	775
B (mm)	170	220
C (mm)	305	390
Kg	23	48

STUMP GRINDER BIT

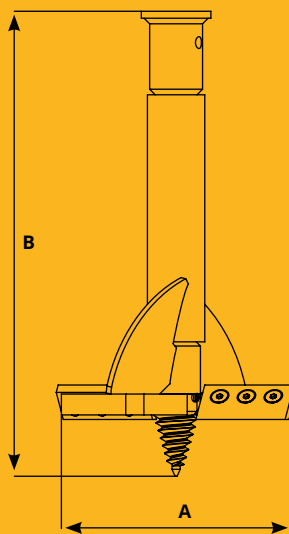
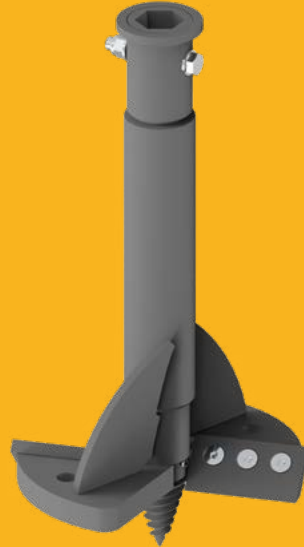
STUMP GRINDER BIT





		
MODEL	V1 - V2 - V3 V4 - V5	V6 - V7 - V8 V9
A (mm)	330	330
B (mm)	670	700
Kg	29	33

BIT SHAFT EXTENSIONS

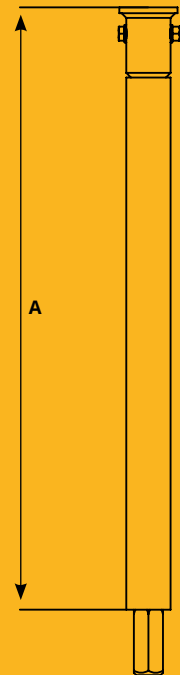
EXTENSIONS WITHOUT
SPIRAL FOR BITS



		
MODEL	V1 - V2 - V3 V4 - V5	V6 - V7 - V8 V9
1000 (mm)	✓	✓
1500 (mm)	✓	✓
2000 (mm)	✓	✓

BIT EXTENSIONS WITH SPIRAL

EXTENSIONS WITH SPIRAL FOR BITS

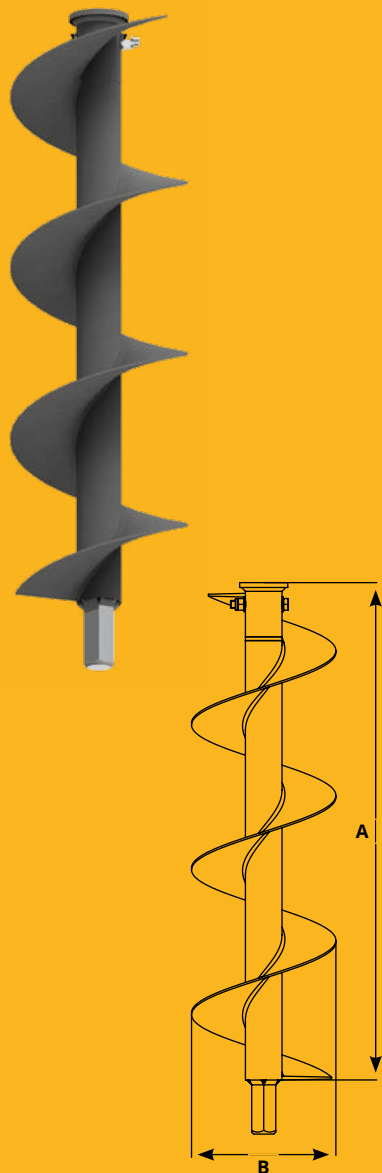

MODEL	V1 - V2 - V3 V4 - V5	V6 - V7 - V8 V9
	 50	 70
SIZE	(A) 1000mm	(A) 2000mm
(B) 100 (mm)	✓	✓
(B) 150 (mm)	✓	✓
(B) 200 (mm)	✓	✓
(B) 250 (mm)	✓	✓
(B) 300 (mm)	✓	✓
(B) 350 (mm)	✓	✓
(B) 400 (mm)	✓	✓
(B) 450 (mm)	✓	✓
(B) 500 (mm)	✓	✓
(B) 600 (mm)	✓	✓

LAND BIT

LAND BIT

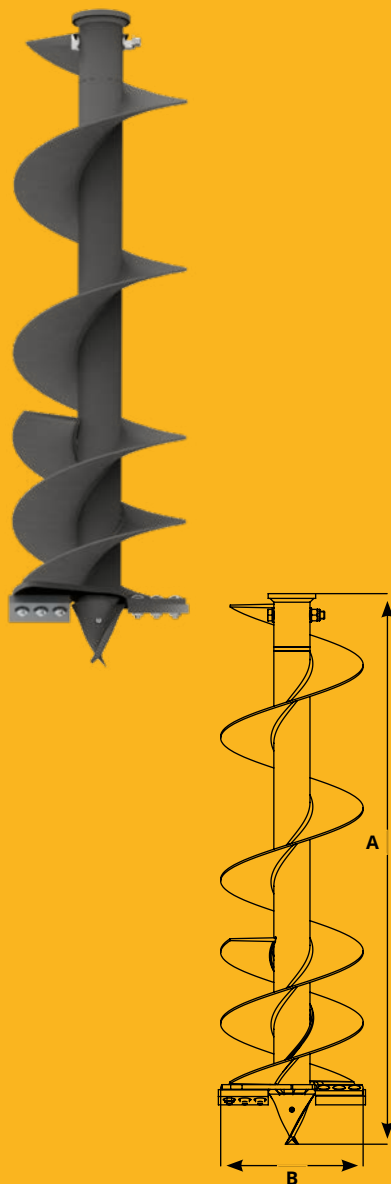

MODEL	V1 - V2 - V3 V4 - V5	V6 - V7 - V8 V9
	 50	 70
SIZE	(A) 1000mm	(A) 2000mm
(B) 100 (mm)	✓	✓
(B) 150 (mm)	✓	✓
(B) 200 (mm)	✓	✓
(B) 250 (mm)	✓	✓
(B) 300 (mm)	✓	✓
(B) 350 (mm)	✓	✓
(B) 400 (mm)	✓	✓
(B) 450 (mm)	✓	✓
(B) 500 (mm)	✓	✓
(B) 600 (mm)	✓	✓

ROCK BIT

ROCK BIT

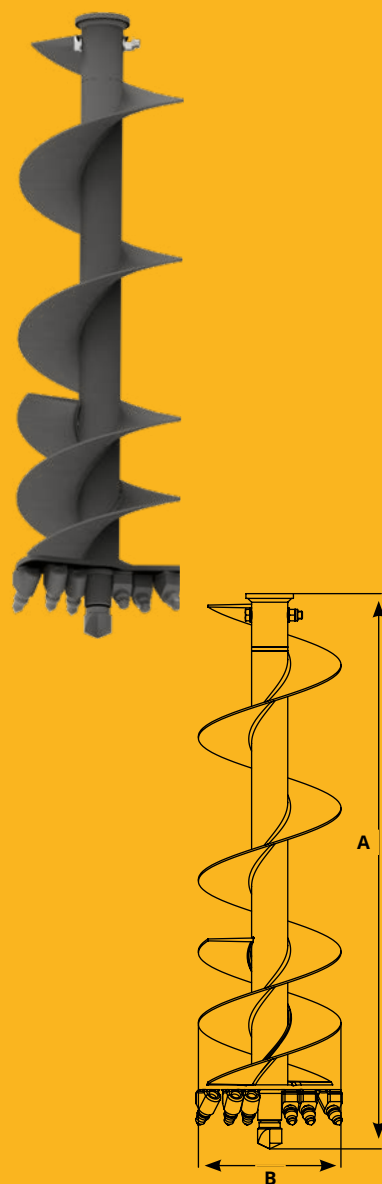

MODEL	V1 - V2 - V3 V4 - V5	V6 - V7 - V8 V9
	 50	 70
SIZE	(A) 1000mm	(A) 2000mm
(B) 100 (mm)	✓	✓
(B) 150 (mm)	✓	✓
(B) 200 (mm)	✓	✓
(B) 250 (mm)	✓	✓
(B) 300 (mm)	✓	✓
(B) 350 (mm)	✓	✓
(B) 400 (mm)	✓	✓
(B) 450 (mm)	✓	✓
(B) 500 (mm)	✓	✓
(B) 600 (mm)	✓	✓



VORTEX 2
V1
1200 Nm
MALAGUTI
L'ARTIGIANO EQUIPMENT





LAND BIT EXTRA

LAND BIT EXTRA

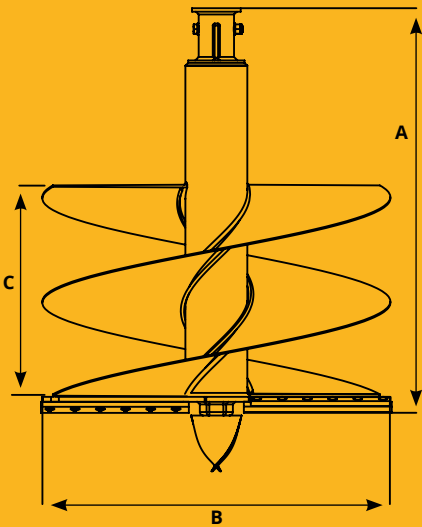

ROCK BIT EXTRA

ROCK BIT EXTRA

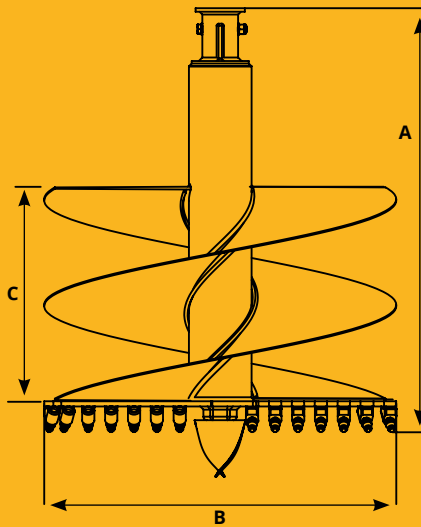

SINGLE PIN ATTACHMENT

SINGLE PIN ATTACHMENT



MODEL	V1 - V2 - V3 V4 - V5	V6 - V7 - V8 V9
	50	70
SIZE	(A) 1000mm	(A) 1000mm
(B) 800 (mm) (C) 600 (mm)	✓	✓
(B) 1000 (mm) (C) 600 (mm)	✓	✓

MODEL	V1 - V2 - V3 V4 - V5	V6 - V7 - V8 V9
	50	70
SIZE	(A) 1000mm	(A) 1000mm
(B) 800 (mm) (C) 600 (mm)	✓	✓
(B) 1000 (mm) (C) 600 (mm)	✓	✓

MODEL	V1 - V2 - V3 V4 - V5	V6 - V7 - V8 V9
Kg	15	40

DOUBLE JOINT ATTACHMENT

DOUBLE JOINT ATTACHMENT



HORIZONTAL ATTACHMENT

HORIZONTAL ATTACHMENT



RIGID ATTACHMENT

RIGID ATTACHMENT



MODEL	V1	V2 V3	V4 V5	V6	V7 V8 V9
Kg	25	26	35	65	86

MODEL	V1	V2 V3	V4 V5	V6	V7 V8 V9
Kg	31	32	40	75	96

MODEL	V1	V2 V3	V4 V5	V6	V7 V8 V9
Kg	15	16	25	33	55